

Cygnus 2⁺

Multi-mode Ultrasonic Thickness Gauge

Operating Manual



Covers Gauge Model : M5-C2P

Doc No. M5-CYG2P-M-01_Iss13.doc
03 September 2021

Contents

- 1. Important Notice 5**
- 2. Introduction..... 6**
 - Cygnus 2+ Thickness Gauge6
 - Cygnus Instruments.....7
 - Gauge Kit Contents8
 - Basic Gauge Kit8
 - Kit supplied with Single Element Probe.....8
 - Kit supplied with Twin Element Probe.....8
- 3. Gauge Preparation 9**
 - Fitting the Batteries9
 - Connecting the Probe 10
 - Fitting the Hand Strap or Belt Clip 11
 - Fitting the Neck Strap 12
- 4. Selecting the Right Probe..... 14**
 - Measuring Metals..... 14
 - Measurement Modes Explained and Compared 15
 - Multiple Echo Mode (ME) (Mode 3)..... 15
 - Single Echo Mode (SE) (Mode 2) 15
 - Echo-Echo Mode (EE) (Mode 3) 16
 - Measuring Non-Steels 16
 - Measuring Non-Metals 17
 - Single Element Probes and Protective Membranes..... 17
 - Summary of Cygnus Probes 20
 - Twin Element probes 20
 - Single Element probes 20
 - The 'Probe Type' Code 21
- 5. Gauge Operation 22**
 - Gauge Controls 22
 - Turning the Gauge On 23
 - Turning the Gauge Off 23
 - Automatic Power Off..... 23
 - 'No Probe' Message 23
 - Taking Thickness Measurements 24
 - Zeroing the Probe (twin element probes) 24
 - Taking the Thickness Measurement..... 24
 - Echo Indicators in Multiple Echo Mode 25
 - Measurement Stability Indication in SE & EE Modes..... 25
 - Measuring Small Diameter Pipe & Tubes..... 26

Battery Life.....	27
Battery Level	27
Low Battery Warning.....	27
6. Calibration	28
Why should I Calibrate my Thickness Gauge?.....	28
Calibration Options	29
Calibrating to a known thickness (Single or 1 Point).....	29
Two Point Calibration	31
Ladder Step Wedge	31
Two Point Calibration Procedure	31
Probe Zero (twin element probes).....	33
Starting a Probe Zero from the Main Menu	34
Probe Zero Function	34
Setting the Velocity of Sound	35
7. Gauge Setup	37
Main Menu Operation	37
Settings are Saved with the Probe Type	38
Selecting the Probe Type	39
Automatic Probe Detection	40
Measurement Units	41
Resolution Setting	42
Deep Coat Function (multiple echo mode)	43
Vibrate Alert Function.....	45
Display Rotate Function	46
8. General Points On Thickness Gauging	48
9. Troubleshooting	49
The Gauge will not Switch On	49
Difficulty obtaining a Reading	49
If Readings are Erratic or Unstable	49
Tips for Optimising Battery Life.....	49
10. Updating your Gauge.....	51
Update Software.....	51
Gauge Firmware Files	51
11. Care and Servicing	52
Cleaning the Gauge.....	52
Batteries	52
Environmental.....	52
Storage.....	52
Repairs	52

Returning the Gauge for Servicing.....	53
12. Information.....	54
Technical Specifications	54
Table of Sound Velocities	57
Reading Conversions	58
13. Recycling and Disposal (EC Countries).....	60
14. Warranty Information	61
15. Index	62

1. Important Notice



The following important information must be read and understood by all users of Cygnus ultrasonic thickness gauges.

The correct use of Cygnus ultrasonic thickness gauges requires identification of the correct equipment for the specific application coupled with an appropriately trained and qualified operator or technician. The incorrect use of this equipment, along with its incorrect calibration, can result in serious financial loss due to damage to components, facilities, personal injury and even death.

Neither Cygnus Instruments nor any of its employees or representatives can be held responsible for improper use of this equipment. Proper training, a complete understanding of ultrasonic wave propagation, thorough reading of this manual, proper transducer selection, correct zeroing of the transducer, correct sound velocity, correct use of the appropriate test blocks, proper cable length and proper couplant selection all play a factor in successful ultrasonic thickness gauging. Of critical importance is the process of complete and accurate calibration of the instrument.

This manual will provide instructions in the set up and operation of the thickness gauge. Additional factors that can affect the use of ultrasonic equipment are beyond the scope of this manual and to that end it is understood that the operator of this equipment is a well-trained inspector qualified by either their own organisation or another outside agency to the appropriate level of both theory and practical application of ultrasonics .

Therefore Cygnus Instruments recommends that users of its ultrasonic thickness gauges should be formally qualified to a minimum of UT "Level 1" (ASNT or PCN) which will provide approximately 40 hours of training.

2. Introduction

Cygnus 2+ Thickness Gauge

The **Cygnus 2+ Ultrasonic Thickness Gauge** is a rugged, handheld, battery-powered instrument designed for high-reliability thickness measurements in harsh environments using ultrasound.

The gauge can be used with a choice of Ultrasonic Probes, selected to suit the material and thickness range to be measured.

The gauge can measure material thickness using three methods; Single Echo, Echo-Echo or Multiple Echo. Echo-Echo and Multiple Echo allow measurements through surface coatings which are ignored.

Measurements can be displayed in either Metric (mm) or in Imperial (inch) units. The gauge has an end-mounted LCD graphic display which can be easily read in most light situations.

The gauge can easily be calibrated to a known thickness or to a known Velocity of Sound.

The gauge is able to operate accurately over a wide range of ambient temperatures and is environmentally sealed to IP67 for use in wet conditions.



The gauge is a solid-state electronic instrument which, under normal operating conditions, will give many years of active service.

Although designed for ease of operation the first time user should carefully read this manual to familiarise themselves with the features of the Gauge.

Cygnus Instruments

Cygnus Instruments Limited, founded in 1983, pioneered the development of the Digital *Ultrasonic Multiple-Echo Technique* used for measurement through coatings. This has long since been the standard required to ensure that accurate measurements are taken without the need to zero the gauge or remove any coatings first.

Our philosophy is to work closely our customers to provide high quality products, engineered to serve heavy industry & harsh environments. Cygnus Ultrasonic thickness gauges are designed to be reliable and simple to use. We have an unrivalled reputation in over 45 countries around the world.



CYGNUS Instruments Ltd.

Cygnus House, 30 Prince of Wales Road,
Dorchester, Dorset, DT1 1PW England.
Website: www.cygnus-instruments.com
Tel: 00 44 (0) 1305 265533
Fax: 00 44 (0) 1305 269960
sales@cygnus-instruments.com

Cygnus UAE Cygnus Instruments Middle East

P.O. Box 127267
Jebel Ali Free Zone (JAFZA)
Dubai, UAE
Website: www.cygnus-instruments.com
Telephone: +971 50 3459305
E-mail: sales@cygnus-instruments.com

CYGNUS Instruments Inc.

Cygnus Instruments, Inc.
6900 Phillips Hwy, Suite 8
Jacksonville, FL 32216, USA.
Tel: 00 1 410 267 9771
Fax: 00 1 410 268 2013
www.cygnusinstruments.com
sales@cygnusinstruments.com

CYGNUS Singapore (S) Pty. Ltd.

63 Jalan Pemimpin
#04-01 Pemimpin Industrial Building
Singapore 577219
Tel : (+65) 6252 5909
Fax : (+65) 6251 1318
www.cygnus-instruments.sg
sales@cygnus-instruments.sg

Gauge Kit Contents

Basic Gauge Kit

1. Cygnus 2 Gauge
2. Operating Manual (in side pouch)
3. Neck Strap (in side pouch)
4. Accessory Pouch, containing; 3 x AA Batteries, Blue Couplant Gel.

Kit supplied with Single Element Probe

1. Ultrasonic Probe
2. Moulded Probe Cable (in side pouch)
3. 15mm (or 1/2") Steel Test Block
4. Spare Membranes
5. Membrane Key
6. Membrane Couplant

Kit supplied with Twin Element Probe

1. Ultrasonic Probe
2. Moulded Probe Cable (in side pouch)



3. Gauge Preparation

The gauge is supplied ready to use out of the box. Just insert the batteries, connect the probe to the gauge, turn on the power and you are ready to take thickness measurements.

Fitting the Batteries

The gauge requires 3 x AA/LR6/UM3 Batteries. Cygnus supplies and recommends Duracell Alkaline batteries. The batteries are located behind a cover on the rear of gauge. The hand strap can be separated by a push-button buckle to gain access to the battery cover. The battery cover is removed by pressing in with your thumb the at the base to release the clip.



Press the bottom of the battery cover to release the retaining clip and lift up the battery cover.



The batteries are located underneath.

The gauge is protected against electrical damage from incorrect battery insertion.

The battery compartment itself is sealed to contain any battery fluids that may leak out.



The gauge can be fitted with NiCad or NiMH rechargeable batteries but this may alter the specified operating time.



To avoid damage from leaking batteries **always** remove the batteries if the gauge will be unused for any length of time.

If the batteries run flat they may leak acid into the battery compartment and damage the electrical contacts. This would not be covered by the warranty.

Connecting the Probe

The Cygnus probe lead uses a custom made cable that offers superior flexibility and resistance to oils and ultraviolet light. The cable will not stiffen after exposure to ultraviolet light.

The connector uses original Lemo connectors for reliability. The twin connectors are over-moulded to form a tough housing that will provide a long lasting probe cable

The connector is orientated with a 'pip' and can only be plugged in one-way around.

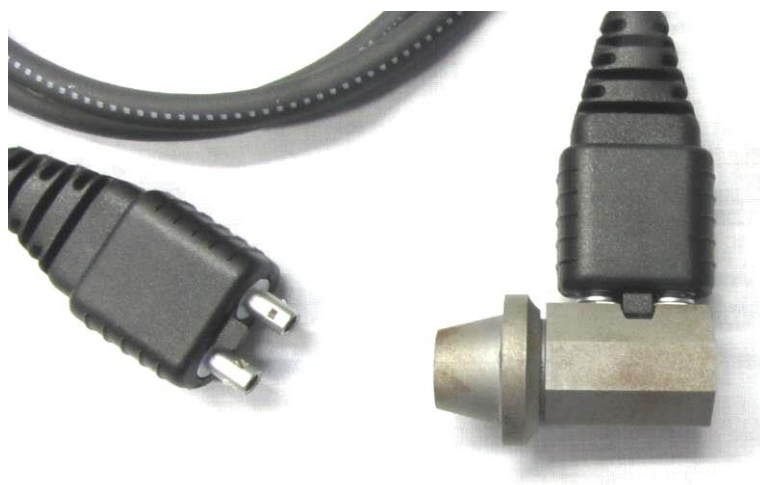

Depending on the type of probe supplied the probe end will have either a twin Lemo 00, BNC or single Lemo 00 connector.



To release the connector simply pull back on the connector body. DO NOT pull the cable.

Fitting the Hand Strap or Belt Clip

The gauge is supplied fitted with an adjustable elasticated Hand Strap. This can be easily removed and the optional Krusell® belt clip attachment fitted instead.



Elasticated Hand Strap



Optional Krusell® belt clip attachment parts.



There are four Pozidrive screws holding the hand strap or Krusell® belt clip attachment in place. Two are under the battery cover.

Fitting the Neck Strap

The gauge is supplied with an adjustable Neck Strap. The ends of the neck strap clip onto two wire loops fitted to the gauge. These wire loops are made from coated stainless steel.



Wire loop fitted to the gauge body.

Simply pass the loop through the hole in the gauge and back over the other end.



The neck strap can then be clipped on to the loops.

4. Selecting the Right Probe

The performance of any thickness gauge, and its ability to get a reliable measurement depends on selecting the right ultrasonic probe for the application and conditions. Cygnus gauges are therefore offered with a selection of probes suitable for most thickness gauging applications.

The following section helps you select the right probe for the application.



The gauge **must** be set for the probe connected to it, see Selecting the Probe Type on page 39.

Measuring Metals

Material	Coating	Corrosion	Thickness	Recommended..	
				Probe	Measurement Mode
Steels	Any	Non to Moderate	1 mm+	S5A	Multiple Echo
Steels	Any	Non to Moderate	2 mm+	S3C	Multiple Echo
Steels	Any	Non to Moderate	3 mm+	S2C	Multiple Echo
Steels	Non	Non to Heavy	0.8 mm+ (0.03"+)	T7A	Single Echo
Steels	Non	Non to Heavy	1.5 mm+ (0.06"+)	T5B	Single Echo
Cast Iron	Non	Non to Moderate	2.5 mm+ (0.1"+)	T2C	Single Echo

The table above shows that to be able to measure coated and uncoated steels with non to heavy corrosion ideally you will require at least two probes, in almost all applications this will be a **S2C** probe and a **T5B** probe.



When measuring in Multiple Echo mode the coating will be ignored and just the metal thickness measured.



It is possible to use a Twin Element (T**) probe in Echo-Echo Mode to ignore thin paint coatings. However this method does not have the ability to verify measurements and without an A-Scan display it is possible to get incorrect measurements.

Measurement Modes Explained and Compared

Multiple Echo Mode (ME) (Mode 3)

Multiple Echo measurement mode is by far the most reliable and easy method for thickness measurements, because it works by looking for three matched echoes it can verify the thickness measurement is valid. This method has been used in all Cygnus gauges since the late 1970s.

Multiple echo mode will ignore surface coatings (Through Coating mode), there is no need to remove the paint to take a measurement.

Also because it uses a single element (or single crystal) probe there are no errors due to the V-path of the ultrasound beam found in all twin element probes. This makes it simple to calibrate – two point calibrations are not required.

However because it requires three echoes to take a measurement, in heavily corroded steels there is often an insufficient number of echoes so no measurement is possible.

Single Echo Mode (SE) (Mode 2)

Single Echo measurement mode is most useful on heavily corroded metals where Multiple Echo fails. Because it only needs the first return echo to take a measurement it performs well on virtually all steel conditions.

However single echo mode will not ignore any surface coatings, so if you measure through a coating it will give an incorrectly metal thickness measurement . If the surface coating is very thin paint (0.2mm / 0.01”) you can make an allowance for this error, but thicker coatings introduce too much error to be practical.

Single echo measurements use a twin element (twin element) probe, because there are two elements angled to a focal point there is a v-path error introduced. However this v-path error is mostly corrected by the gauge, and furthermore by performing a two point calibration.

Twin element probes require "zeroing" at regular intervals, especially if the ambient temperature is changing.

Echo-Echo Mode (EE) (Mode 3)

Echo-Echo mode uses a twin element probe, but measures between the first two echoes. This method is intended to ignore any thin surface coatings whilst still using a twin element probe.

Echo-echo mode is not able to verify its measurements unlike Multiple echo mode, therefore it is liable to give incorrect readings. As the Cygnus 2⁺ gauge does not have an A-Scan display there is no way the user can check the measurement is correct.

Echo-echo mode must therefore be used with caution, and only on thin paint surface coatings (less than 0.5mm). It is recommended a Single Echo measurement should also be made to help verify the measurement makes sense (the Single Echo measurement should always be slightly thicker due to the coating thickness).

Measuring Non-Steels

The gauge will measure the following non-steels;

- Aluminium alloys
- Copper and Brass alloys
- Titanium

Use the same rules as steels when selecting a suitable probe. The gauge will ideally be re-calibrated to suit the metal being measured, or the standard velocity of sound for that material would be entered into the gauge.

Measuring Non-Metals

You can measure certain types of plastics with the gauge using a twin element probe and the gauge set to Single Echo measurement mode. Generally the harder the plastic the better, soft materials like rubber or TPEs tend to absorb too much ultrasound so only thin samples can be measured.

Engineering plastics like Acetal, Tufset (Polyurethane), Nylon and High-density polyethylene (HDPE) can be measured successfully.

Rotationally moulded parts can generally be measured successfully.

- You must use Single Echo mode to measure plastics.
- You must generally use a low frequency probe (i.e. **T2C**) to measure plastics, but this will depend on the properties of the material.
- Any material with a closed-cell construction cannot be measured.
- Any material with internal voids, air bubbles or honeycomb cannot be measured.

Typically these materials cannot be measured with the gauge;

- Concrete
- Wood
- Thermal insulation materials
- Foams
- Composites

Single Element Probes and Protective Membranes

All Cygnus single element probes have a soft face and are therefore fitted with a Polyurethane Membrane which provides better contact on rough surfaces and protects the probe face from wear, prolonging the life of the probe.



Check the membrane regularly as it is important the membrane is changed as soon as it shows any signs of wear.

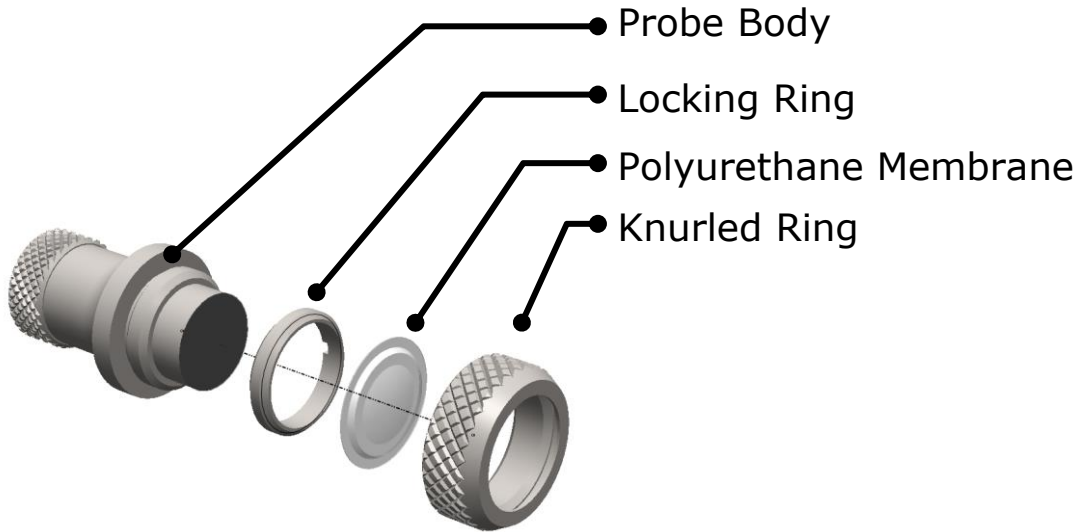



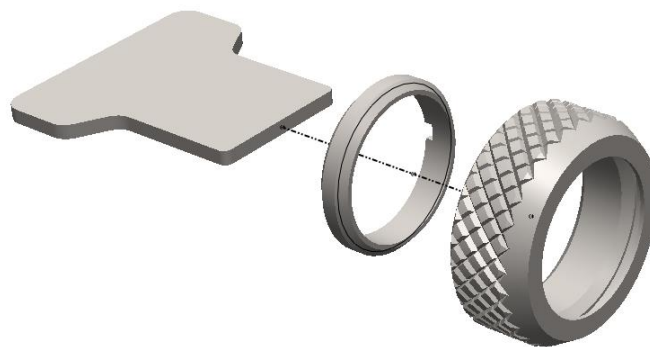

Single Element Probe Membrane Parts.

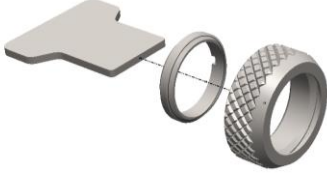
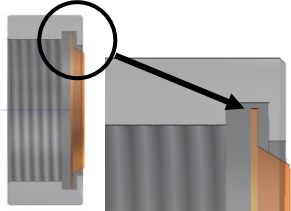
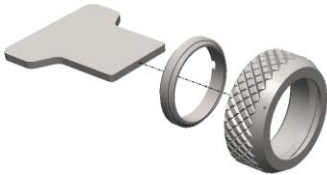

Single Element Probe Membrane Locking Key

Changing the Protective Membrane on Single element Probes

<p>1.</p>	<p>Unscrew the Knurled Ring from the end of the Probe.</p>	
<p>2.</p>	<p>Use the Membrane Key to unscrew the Locking Ring from inside the Knurled Ring. The old membrane can then be removed and discarded.</p>	
<p>3.</p>	<p>Place a new membrane into the end of the Knurled Ring ensuring it locates in the groove.</p>	
<p>4.</p>	<p>Screw the Locking Ring back inside the Knurled Ring and tighten with the Membrane Key.</p>	
<p>5.</p>	<p>Place a few drops of Membrane Couplant on to the probe face.</p>	
<p>6.</p>	<p>Screw the Knurled Ring back onto the probe. Use your thumb to squeeze the couplant from under the membrane as you tighten the Knurled Ring down.</p>	
<p>7.</p>	<p>You should see the membrane has a very thin film of couplant between itself and the probe face with <u>no air bubbles</u>.</p>	

Measuring Higher Temperatures

The polyurethane membranes fitted to the single element probes are suitable for measuring surface temperatures up to **70°C** (160°F). For measuring higher temperatures Teflon membranes are available and suitable for surface temperatures up to **150°C** (300°F) with intermittent contact. Contact Cygnus instruments to order Teflon membranes.

When measuring high temperatures limit the time the probe is in contact with the hot surface to less than 4 seconds and ensure the probe has sufficient time between measurements to cool down.

Summary of Cygnus Probes

Twin Element probes

Probe Type	Size	Frequency	Range in Steel (SE Mode)	Typical Uses
T2C	12mm	2 MHz	2.5 to 250 mm 0.1 to 10"	Attenuative materials Cast irons, plastics
T5B-CSL	8mm	5 MHz	1.5 to 200 mm 0.06 to 8"	General purpose Most metals
T5B-CSW	8mm	5 MHz	1.5 to 200 mm 0.06 to 8"	General purpose Most metals Note: Smaller probe body than T5B-CSL, fixed cable.
T7A	5mm	7.5 MHz	0.8 to 50 mm 0.03 to 2"	Thin metals

Single Element probes

Probe Type	Size	Frequency	Range in Steel	Typical Uses
S2C	13mm	2.25 MHz	3 to 250 mm	General purpose probe suitable for most applications that can use Multiple Echo measurement.

				Coated metals
S3C	13mm	3.5 MHz	2 to 150 mm	Coated metals
S5C	13mm	5.0 MHz	1 to 50 mm	Coated metals
S5A	6mm	5.0 MHz	1 to 50 mm	Small diameter tubes Thin metals Coated metals

The 'Probe Type' Code

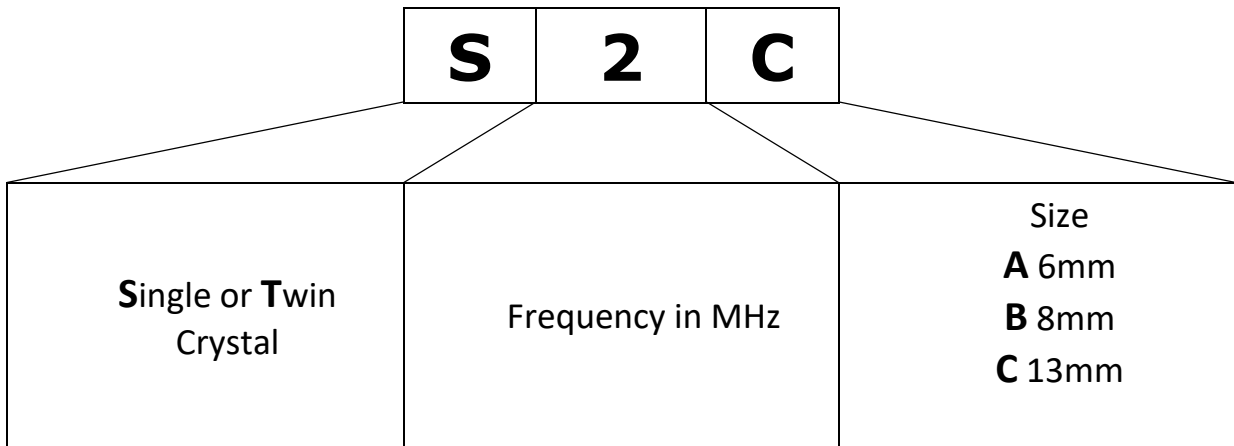

5. Gauge Operation

Gauge Controls



LCD Display

Probe Connection

End view of gauge







Menu Key

Power / Cancel Key



Select Keys

Front view of gauge

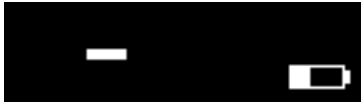
Turning the Gauge On

1.	Press the Power key	
2.	Cygnus Instruments name is displayed	
3.	The model and serial number are displayed	
4.	The firmware & hardware version are displayed	
5.	The gauge is ready to use	

Turning the Gauge Off

1.	Press & Hold the Power key,	
2.	The display shows 'power-off' and the gauge turns off.	

Automatic Power Off

The gauge will turn off automatically after 5 minutes of in activity.

Taking thickness measurements or accessing the menu will reset the 5 minute timer back to zero.

'No Probe' Message

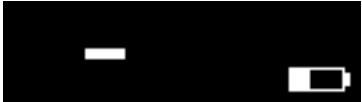
1.	If the gauge cannot detect a probe a message will be displayed.	
2.	This message should disappear when a probe is connected to the gauge.	

Taking Thickness Measurements

Taking ultrasonic thickness measurements is a straight forward process that involves first making sure the surface is clean and prepared, applying an ultrasonic couplant gel then placing the probe on the surface and observing the display for the measurement.

Zeroing the Probe (twin element probes)

When a twin element probe is connected to the gauge (and the gauge is set to the correct probe) you must first perform a **Probe Zero** before you can begin taking measurements. For instructions see Probe Zero Function on page 34.

 It is recommended to frequently perform a Probe Zero if conditions such as temperature are changing.

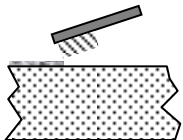
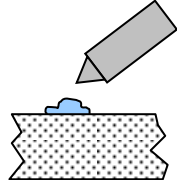
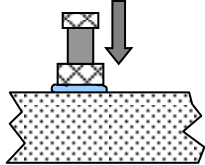
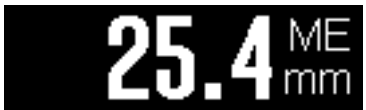

Taking the Thickness Measurement

<p>1.</p>	<p>Remove all scale, rust, dirt or loose coatings and brush the test area clean.</p>	
<p>2.</p>	<p>Apply ultrasonic couplant to the test surface.</p>	
<p>3.</p>	<p>Place the probe-face on the clean, lubricated test surface and make firm contact applying gentle pressure.</p>	
<p>4.</p>	<p>The gauge will display a thickness measurement. (Or an indication of Echo Strength if no valid measurement has been found in Multiple Echo mode).</p>	

<p>5.</p>	<p>When a thickness measurement is displayed the display also shows the Measurement Mode and the Units.</p> <p>SE = Single Echo mode EE = Echo-Echo mode ME = Multiple Echo mode</p>	
------------------	--	---

Echo Indicators in Multiple Echo Mode

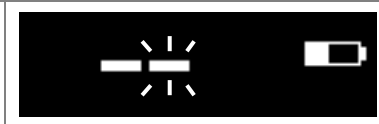
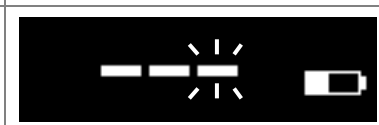
Should the gauge be unable to detect a stable multiple echo signal it displays an Echo indication to help the operator locate a suitable position.

<p>1.</p>	<p>1 Bar Flashing: <i>No echoes detected</i></p>	
<p>2.</p>	<p>1 steady + 1 Bar Flashing: <i>Only 1 echo detected</i></p>	
<p>3.</p>	<p>2 steady + 1 Bar Flashing: <i>Only 2 echoes detected</i></p>	
<p>4.</p>	<p>3 steady + 1 Bar Flashing: <i>3 echoes detected but they are not matched</i></p>	



To help obtain a multiple echo reading the operator should continue to move the probe around to locate a suitable reflector, using a slight rocking motion.

Measurement Stability Indication in SE & EE Modes

To help indicate when a Single Echo or Echo-Echo measurement is stable – and thus probably reliable – the gauge changes the thickness measurement number from Hollow to Solid when the measurement has been stable for 2 consecutive seconds.

When measuring using Single Echo or Echo-Echo mode once you have a measurement keep the probe still and wait for the gauge to signal a “stable reading”.

If the ultrasound signal is poor or erratic then the thickness value may remain hollow – thus indicating the measurement may not be reliable.

<p>1.</p>	<p>Initial measurements will be displayed as hollow numbers.</p>	
<p>2.</p>	<p>If the measurement remains stable for 2 consecutive seconds then the measurement will change to solid.</p>	

Stable is defined as; the thickness measurement changing no more than + or - the Resolution setting.

Example.

The Resolution is set to 0.05mm, therefore the thickness measurement must not change by more than +0.05mm or -0.05mm for 2 seconds or more to be "stable".

Measuring Small Diameter Pipe & Tubes

When measuring small diameter pipe and tubes with a twin element probe, 75mm (3") or under, you must ensure the face of the probe is correctly aligned to the curvature of the pipe otherwise measurements may be inaccurate.

! The dividing line on the face of the probe should be at right angles to the length of the pipe.

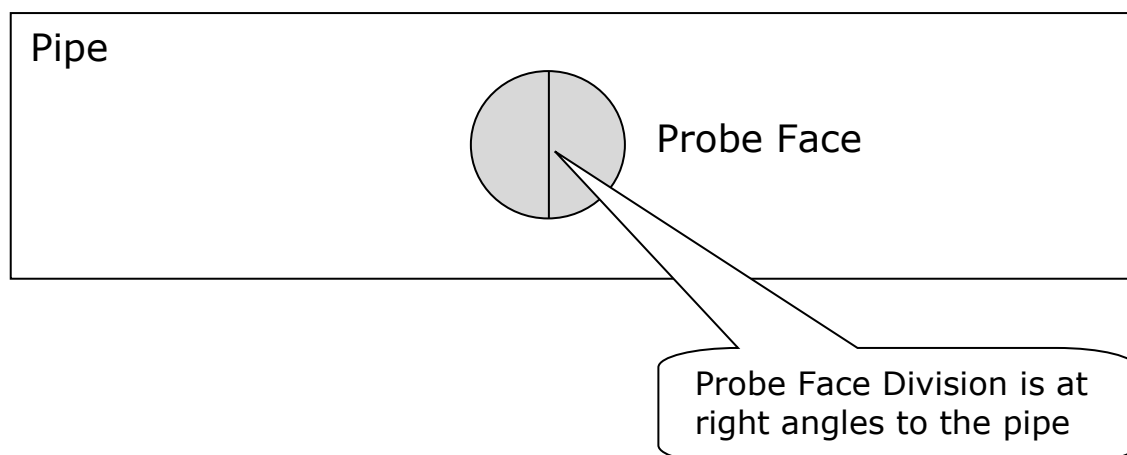



Battery Life

The gauge will operate continuously for approximately 10 hrs when fitted with Duracell Alkaline 1500 mA/hr batteries.

Battery Level

When not displaying a thickness measurement the display shows a battery level gauge.

Note. The battery level gauge moves slowly up and down the display to avoid display "burn in".

Battery almost full	
Battery about 1/3 full	
Battery flat	

Low Battery Warning

The gauge will periodically flash a Low Battery warning message when the batteries have approximately 1 hour of use remaining.

Low battery warning	
---------------------	---

When the batteries are exhausted the gauge will display a **Flat Battery** message for 5 seconds then turn off automatically.

Turn off message	
------------------	---

6. Calibration

Why should I Calibrate my Thickness Gauge?

Ultrasonic thickness gauges measure time in order to measure the thickness of the material being tested. They rely on the principle that sound travels through a material at a constant velocity or speed. If you can accurately measure the time it takes to travel through a material and you know its velocity then you can calculate its thickness;

$$\text{Thickness} = \frac{\text{time} \times \text{velocity}}{2}$$

Modern thickness gauges are easily capable of measuring **time** accurately to 10 nano seconds (0.000,000,01 seconds) so this is considered to be more than sufficiently accurate.

This means the accuracy of any thickness gauge measurement relies principally on the **velocity** being correct for the material being measured.

There are tables listing the velocity of most common metals and materials, but these velocities are only "typical" values. For example Mild Steel has a typical velocity of 5920 m/s – but in practice when measuring a variety of mild steel samples the velocity can range anywhere from 5860 to 5980 m/s.

This means if you want to achieve the most accurate thickness measurements you must calibrate your thickness gauge to a sample of the same material you will be testing – and a sample that you can accurately measure the thickness of with a Vernier or micrometer.

Your measurements are only as good as your calibration

Instructions for calibrating the gauge can be found on page 29 onwards.

Calibration Options

The Gauge is supplied tested and calibrated. The Gauge will have been calibrated to measure thickness through steel (grade S355JO) with a velocity of sound of 5920 m/s.

Either a 15mm or 1/2" **Test Block** is supplied with the kit so the Gauge can be quickly checked for correct operation. Note, this test block is not intended to be used for calibration of the Gauge.

! The best way to calibrate the Gauge is to Calibrate to a Known Thickness using a sample of the material you intend to measure. This method determines the velocity of sound for the material sample, which will always be more accurate than using a 'general' velocity value. For calibration instructions see Calibrating to a known thickness (Single or 1 Point) on page 29 and Two Point Calibration on page 29.

If there is no test sample available the Gauge can be calibrated by Setting the Velocity of Sound directly. A Table of Sound Velocities on page 57 lists common materials and their velocity of sound value. For instructions on Setting the Velocity of Sound see page 35.







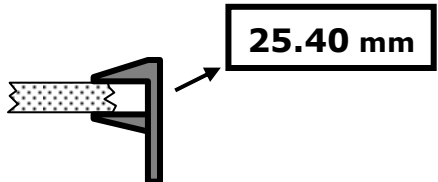

A third method is to leave the Gauge set to its factory-preset value for Steel [5920 m/s or 0.2332 in/us], and then use a Conversion Factor from the Table of Sound Velocities on page 57.

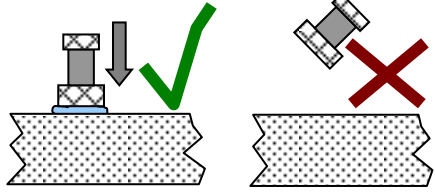
Calibrating to a known thickness (Single or 1 Point)

This method of calibrating the gauge is more accurate than using a standard velocity value as the gauge calculates the velocity of sound for the sample material.

You can use this calibration method for all measurement modes.

<p>1. Accurately measure the thickness of your sample material.</p>	
--	--

<p>2.</p>	<p>Place the Probe on the sample and verify the gauge can get a thickness value.</p>	
<p>3.</p>	<p>Press the Menu key</p>	
<p>4.</p>	<p>Press the Up Select key to get to the Calibrate Single Point item</p>	 
<p>5.</p>	<p>Press the Menu key to start calibration</p>	
<p>6.</p>	<p>While holding the probe firmly on the sample, and while a steady thickness measurement is displayed..</p>	
<p>7.</p>	<p>...use the Up and Down Select keys to adjust the thickness to the required value.</p>	
<p>8.</p>	<p>When done press the Menu key to save the calibration. Or press the Power / Cancel to exit without saving the calibration.</p>	 

Two Point Calibration

The Two Point Calibration option is only available in Single Echo and Echo-Echo modes.

Two point calibration allows the gauge to be calibrated against two reference thicknesses of the same material, one at the minimum (thin) thickness range the other at the maximum (thick) thickness range.

! To achieve maximum accuracy in Single Echo mode you must perform a Two Point Calibration – your measurement is only as good as your calibration.

When performing a two point calibration both sample thicknesses should be made from the same material. The temperature of the sample material should be the close to the temperature of the material to be measured.

The gauge will automatically compensate for v-path error in addition to either single or two point calibrations.

Ladder Step Wedge



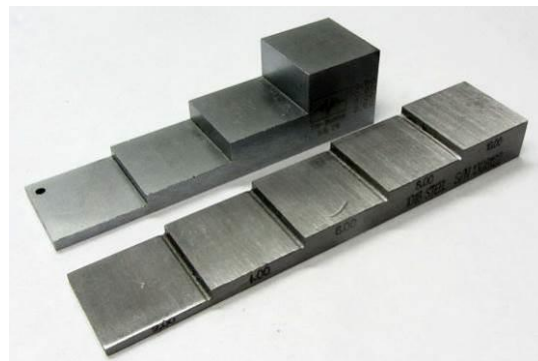



Typically a Ladder Step Wedge is used to calibrate the probe and gauge for Steel. The ladder step wedge has 4 or 5 different thicknesses typically ranging from 2.5 mm to 20.0 mm. You would typically choose to calibrate using the 2.5 and 20 mm thicknesses.



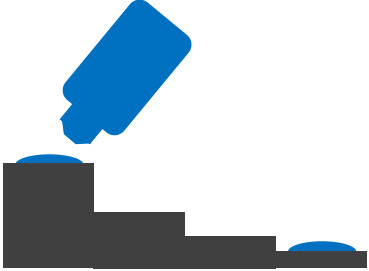







Ladder Step Wedges

Two Point Calibration Procedure

<p>1.</p>	<p>Assuming you have a step wedge of known thicknesses</p>	
------------------	--	--

<p>2.</p>	<p>Wipe clean the step wedge then add some fresh couplant to the step wedge</p>	
<p>3.</p>	<p>Place the Probe on the sample and verify the gauge can get a thickness value.</p>	
<p>4.</p>	<p>Press the Menu key</p>	
<p>5.</p>	<p>Press the Up Select key to get to the Calibrate Two Point item</p>	 
<p>6.</p>	<p>Press the Menu key to start calibration</p>	
<p>7.</p>	<p>Start with the Thick sample - Maximum thickness. While holding the probe firmly on the thick sample, and while a steady thickness measurement is displayed..</p>	

	...use the Up and Down Select keys to adjust the thickness to the required value.	 
8.	When the correct measurement is displayed press the menu key	
9.	Next measure the Thin sample – Minimum thickness. While holding the probe firmly on the thin sample, and while a steady thickness measurement is displayed..	
	...use the Up and Down Select keys to adjust the thickness to the required value.	 
10.	When done press the Menu key to save the calibration. Or press the Power / Cancel to exit without saving the calibration.	 

Probe Zero (twin element probes)

Twin element probes must be zeroed to compensate for any wear or operating temperature changes. The gauge will always perform





a Probe Zero when first turned on or when a twin element probe is connected.

If the probe gets significantly warmer during use this can cause a shift in the zero position and thus introduce small errors in the thickness measurement. Typically a 20° C change in temperature the measurements can shift by 0.1 mm.

! It is recommended to frequently perform a Probe Zero if conditions such as temperature are changing.



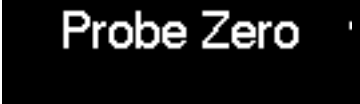

See also Zeroing the Probe (twin element probes) on page 24.

Starting a Probe Zero from the Main Menu

<p>1.</p>	<p>Press the Menu key</p>	
<p>2.</p>	<p>Press the Up Select key to get to the Probe Zero item</p>	 
<p>3.</p>	<p>Press the Menu key</p>	

Probe Zero Function

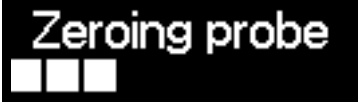
<p>4.</p>	<p>Display shows the Zero Probe message.</p>	
------------------	--	---

5.	Press the Up select key to proceed	
6.	Wipe any couplant from the probe face	
7.	Press the Up select key to proceed	
8.	The gauge measures the probe zero point.	
9.	<p>If the Probe Zero fails a message will be displayed.</p> <ul style="list-style-type: none"> • Check the probe has not been unplugged or the cable is damaged/faulty. • The probe face must be clean and in the air. • Are you using a non-Cygnus probe? 	

Setting the Velocity of Sound







The gauge uses the Velocity of Sound value to calculate the material thickness value. It is therefore important the velocity value is set for the material being measured.

-  If you perform a Calibration (single or two point) the Velocity of Sound will be set for you during the calibration – so you don't need to adjust it afterwards.

You can manually set the velocity of sound value if required, normally you would do this if;











- You can't perform a calibration
- You want to use the same velocity setting as last time
- You want to use a velocity from a material list

A list of velocity of sound values for common material can be found on page 57.

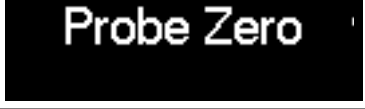





<p>1.</p>	<p>Press the Menu key</p>	
<p>2.</p>	<p>Press the Up Select key to get to the Velocity item</p>	 
<p>3.</p>	<p>Press the Menu key to change the velocity value</p>	
<p>4.</p>	<p>Use the Up and Down Select keys to adjust the velocity value as required</p>	
<p>5.</p>	<p>When done press the Menu key to save the new value. Or press the Power / Cancel to exit without saving.</p>	 

7. Gauge Setup

Main Menu Operation

1.	Press the Menu key..	
2.	..to display the Main Menu.	
3.	Press the Up select key to scroll around the Main Menu items one at a time. The Down select key will scroll in the other direction.	
4.	Change the Measurement Mode	
5.	Set the Probe Type	
6.	Do a Probe Zero (twin element probes only)	
7.	Set the Velocity of sound	
8.	Perform a Single Point Calibration	
9.	Perform a Single Point Calibration (twin element probes only)	
10.	¹ Turn the Deep Coat function on or off (single element probes only)	
11.	Set the measurement Resolution	

¹ Deep Coat must be enabled – contact Cygnus for instructions.

12.	Set measurement Units	
13.	Set the Vibrate option	
14.	Set the Display Rotation option	
15.	To exit the menu press the Power / Cancel key once.	
16.	If you want to change or select the item currently displayed simply press the Menu button	
17.	<p>If the item has a number of choices you can use the Up and Down keys to step through each option.</p> <p><i>Example.</i> <i>Units goes from mm to inch.</i></p>	
18.	<p>To save your choice press the menu key.</p> <p>To cancel without saving press the Power / Cancel key.</p>	

Settings are Saved with the Probe Type

Certain gauge settings are saved against the probe type. This allows each probe type to have different settings that will be recalled when that probe is re-connected and the probe type is correctly set. The following settings are saved with each probe type;

- Measurement mode
- Units
- Resolution
- Velocity of sound
- Calibration
- Deep Coat (if a single element probe)

Selecting the Probe Type

 The Probe Type must be set to the probe connected to it. If the wrong probe is selected the gauge will not measure accurately if at all.



The gauge can Auto Detect certain types of probes when they are first connected to the gauge, or you can manually select the probe from a list.



These probes can be Auto Detected;

T2C, T5B, T7A

These probes must be selected manually;

S2C, S3C, S5A & S5C

<p>1.</p>	<p>Press the Menu key</p>	
<p>2.</p>	<p>Press the Up Select key to get to the Probe Type item</p>	 

<p>3.</p>	<p>Press the Menu key to change the probe type</p>	
<p>4.</p>	<p>Use the Up and Down Select keys to select from Auto or a specific probe type</p>	
<p>5.</p>	<p>When done press the Menu key to save the new value.</p> <p>Or press the Power / Cancel to exit without saving.</p>	

 Remember settings and calibration is saved with each probe type. So if you change the probe type you may find a setting has changed – this is normal.

The reason settings are saves with each probe type is so you can swap probes during a survey without having to re-calibrate each time.

Also you may want Multiple Echo measurements in 0.1mm resolution but Single Echo measurements in 0.01mm resolution.

Automatic Probe Detection

The Automatic Probe Detection works by listening to how the probe behaves when first plugged in. For that reason the probe **MUST BE** in the air and not coupled to a surface when plugging in or turning on the gauge.

When Probe Type = Auto and a probe is connected a message will be displayed informing what type of probe was detected;











Observe this message and check it matches the probe connected to the gauge.

If the gauge fails to correctly detect the probe type then you must select it manually from the list of probes. See Selecting the Probe Type on page 39.

Measurement Units

The Gauge can display thickness measurements in either Metric (mm) or Imperial (inch). Changing the measurement units will not affect the calibration.

<p>1.</p>	<p>Press the Menu key</p>	
<p>2.</p>	<p>Press the Up Select key to get to the Units item</p>	 
<p>3.</p>	<p>Press the Menu key to change the value</p>	
<p>4.</p>	<p>Use the Up and Down Select keys to switch from mm to Inch</p>	

		
5.	When done press the Menu key to save the new value. Or press the Power / Cancel to exit without saving.	 



Resolution Setting





The gauge can display thickness measurements in three resolution settings:

- 0.1 mm 0.005 inch (All modes)
- 0.05 mm 0.002 inch (ME Mode Only)
- 0.01 mm 0.001 inch (SE, EE Mode Only)

For general metal corrosion measurement the 0.1 mm setting is recommended.

To change the Resolution setting:

1.	Press the Menu key	
2.	Press the Up Select key to get to the Resolution item	 

<p>3.</p>	<p>Press the Menu key to change the value</p>	
<p>4.</p>	<p>Use the Up and Down Select keys to switch from mm to Inch</p>	 
<p>5.</p>	<p>When done press the Menu key to save the new value. Or press the Power / Cancel to exit without saving.</p>	 

Deep Coat Function (multiple echo mode)

-  The Deep Coat function is not available from the Main Menu by default. To show the Deep Coat option in the menu please contact Cygnus for instructions.

In Multiple Echo mode with the Deep Coat turned Off the gauge can measure through most protective coatings up to 3 mm (0.11") thick when using a **S2C** type probe. Coatings like paint, anti-foul, hard plastics and epoxy should present no problems as long as they have not de-laminated/de-bonded from the metal surface.

In Multiple Echo mode with Deep Coat turned On will allow the gauge to measure through coatings over 3mm (0.11") thick up to a maximum of around 20 mm (0.78") depending on the properties of the coating material.







Measuring through thick coatings is ultimately limited by how well the coating material allows the ultrasound to pass through, soft

coatings like rubber or bitumen don't transmit ultrasound very well.

Deep Coat is only available in Multiple Echo mode.

Using Deep Coat will not affect the calibration.

 Turn Deep Coat Off when NOT measuring through thick coatings otherwise this may cause inaccurate measurements.



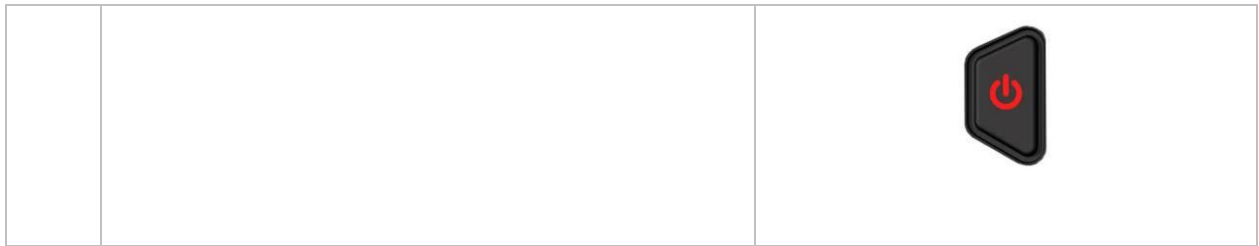

<p>1.</p>	<p>Press the Menu key</p>	
<p>2.</p>	<p>Press the Up Select key to get to the Deep Coat item</p>	 
<p>3.</p>	<p>Press the Menu key to change the value</p>	
<p>4.</p>	<p>Use the Up and Down Select keys to switch from On to Off</p>	 
<p>5.</p>	<p>When done press the Menu key to save the new setting. Or press the Power / Cancel to exit without saving.</p>	



Vibrate Alert Function

The gauge can vibrate to alert the user when a thickness measurement has been made. This feature can be turned on or off as required.

In Single Echo and Echo-Echo measurement modes the vibrate alert will be triggered when a stable measurement is detected. See Measurement Stability Indication in SE & EE Modes on page 25.





1.	Press the Menu key	
2.	Press the Up Select key to get to the Vibrate item	 <div style="background-color: black; color: white; padding: 5px; text-align: center; width: fit-content; margin: 0 auto;">Vibrate off</div>
3.	Press the Menu key to change the value	
4.	Use the Up and Down Select keys to change the setting from On to Off	 <div style="background-color: black; color: white; padding: 5px; text-align: center; width: fit-content; margin: 0 auto;">Vibrate off</div>





<p>5.</p>	<p>When done press the Menu key to save the new value.</p> <p>Or press the Power / Cancel to exit without saving.</p>	
------------------	---	---

Display Rotate Function

If the gauge is worn on a belt using the Krusell belt clip the end display will be upside down. To rotate the display so it can be read set the Display Rotate function to 'yes'. Now the thickness measurement display will be rotated 180 degrees.

When you remove the gauge from the belt clip and access the Main menu the display will rotate back the normal way around so you can hold the gauge normally.

<p>1.</p>	<p>Press the Menu key</p>	
<p>2.</p>	<p>Press the Up Select key to get to the Rotate Display item</p>	
<p>3.</p>	<p>Press the Menu key to change the value</p>	
<p>4.</p>	<p>Use the Up and Down Select keys to change the setting between yes and no</p>	

	<p>no = don't rotate.</p> <p>yes = rotate 180 degrees</p>	 
5.	<p>When done press the Menu key to save the new setting.</p> <p>Or press the Power / Cancel to exit without saving.</p>	 

8. General Points On Thickness Gauging

On very rough surfaces and especially if both sides are badly corroded, it is often necessary to move the Probe around to locate a back wall reflector. Sometimes a slight rocking movement can help find reflectors which are otherwise impossible.

Badly corroded sections can also be soaked with a light lubricating oil to improve ultrasound coupling through to the good material.

Always ensure that there is plenty of couplant present for good contact, but beware that on a pitted surface the Gauge may just measure the couplant-filled pit, always avoid measuring directly over external pits.

Beware that in extreme conditions or if the plate is of poor quality and contains many inclusions the ultrasound will be scattered to such an extent that measurement may not be possible.

Beware that the multiple-echo technique will not work if the front and back surfaces of the material being measured are not close to parallel. Also note that long narrow bars cannot be gauged along their length with the multiple-echo method.

The Gauge should not be used near arc-welding equipment, as this affects its performance.

9. Troubleshooting

The Gauge will not Switch On

- Are the batteries exhausted?
- Check the batteries are inserted correctly.

Difficulty obtaining a Reading

- Check that the Probe lead is properly connected to both Probe and Gauge.
- Check the gauge is set for the probe connected.
- Check the condition of the lead, replace if necessary.
- Check the Probe and its membrane are properly assembled (if a single element probe).
- On heavily corroded areas this is often a problem, try and take measurements in adjacent areas of the same material. You could also consider using a twin element probe in single echo mode.
- Check the Gauge and Probe together on a test block, if there is still no reading the Gauge may require servicing.

If Readings are Erratic or Unstable

- Check that the Probe-lead is properly connected to both Probe and Gauge.
- Check that the Probe and its membrane are correctly assembled with sufficient couplant between the probe face and membrane (if a single element probe).
- Check the Probe Type is suitable for the probable minimum thickness of the material being measured. Probe frequencies too low cause doubling and tripling of the actual thickness.

Tips for Optimising Battery Life

- Couplant left on the probe face will stop the gauge entering low power saving mode – so wipe couplant off the probe face between measurement sessions.

- When measuring on very heavily corroded metal with single element probes the gauge uses more power searching for a multiple echo match – this can significantly reduce battery life. So if you are frequently measuring on very heavy corrosion consider using a twin element probe as this will require less power to get measurements.

10. Updating your Gauge

As part of our policy of ongoing development and product improvement Cygnus may issue firmware updates for your model of gauge. The firmware on the gauge can be easily updated by the user using update software downloaded from the Cygnus website.

Before updating your gauge note the model and serial number of the gauge (see Turning the Gauge On on page **Error! Bookmark not defined.**). You can then check on the Cygnus website if your gauge has the latest firmware version, and if not proceed to download the update software.

You can check for the latest gauge firmware on the Cygnus website [<http://www.cygnus-instruments.com>]. Navigate to **Support -> Downloads -> Technical Software** and look for a PDF document called 'M5 Surface Gauge Firmware Version Info' view this document to find the latest version for your gauge along with any changes made. *Note you will need to create an account to access this section of the website.*

Update Software

To update a gauge you must first download and install the 'Cygnus M5 Surface Gauge Updater' software. This is available from the Cygnus website in the **Support -> Downloads -> Technical Software** section. There is a PDF document with instructions available.

Gauge Firmware Files

You must download the appropriate Gauge Firmware file for the model of gauge, there are three to choose from; Cygnus 2/2+, Cygnus 4/4+ or Cygnus 6+ PRO.

Once downloaded the gauge can be easily updates via the USB cable connecting the gauge to the computer. The whole process takes about 2 minutes. There is a PDF document with detailed instructions available on the website.

11. Care and Servicing

Cleaning the Gauge

- ✓ Clean the Gauge and accessories with a damp cloth. Use water with a mild detergent household cleaner.
- ✗ Do not use solvents to clean the Gauge.
- ✗ Do not use any abrasive cleaner, especially on the display window.
- ✗ Do not immerse the Gauge in liquid when cleaning.

Batteries

- ✓ Always remove the batteries if the Gauge will not be used for more than a few days.
- ✓ Only use leak-proof batteries, Cygnus recommend Duracell batteries.

Environmental

- ✗ Do not immerse the Gauge in liquids. The gauge is designed to be IP67 but it is not intended for use in water.
- ✗ Do not subject the Gauge to temperatures greater than 50°C (122°F).
- ✗ Do not store the Gauge for long periods in conditions of high humidity.

Storage

- ✗ Do not store the Gauge in temperatures greater than 35°C (95°F).

Repairs

- ✗ There are no user serviceable parts inside the Gauge. Therefore all repair work should be carried out by Cygnus Instruments or by an Authorised Cygnus Service dealer.

Returning the Gauge for Servicing

A full Manufacturer's Factory Service is available from Cygnus Instruments.



The Complete Kit should always be returned for Service or Repair, including all Probes and Leads.

Cygnus Gauges are renowned for their reliability, very often problems with getting measurements are simply due to the way the Gauge is being used.

However, if you do need to return your Gauge for Repair please let us know the details of the problem, to help us guarantee the best possible service:

- Is the problem Intermittent Behaviour?
- Is there a problem turning the Gauge On?
Or a problem with the Gauge turning itself Off?
- Does the Gauge constantly give Incorrect Readings, or Unsteady Readings?
- Is it not possible to Calibrate the Gauge?

12. Information

Technical Specifications

Cygnus M5-C2P Technical Specifications	
General Attributes	
Size	84 mm x 130 mm x 35 mm (W x H x D) (3.3 in x 5.1 in x 1.4 in)
Weight	Gauge with batteries 300 g (10.5 oz.)
Power Supply	3 x AA / R6 Batteries.
Probe Sockets	2 x Lemo 00
Operating Temperature Range	-10°C to +50°C (14°F to 122°F)
Storage Temperature Range	-10°C to +35°C (14°F to 95°F)
Battery Operation Time	Approximately 10 hrs. continuous measurement with fully charged Duracell Alkaline LR6 batteries.
Battery Voltage Range	Min 3.0 V dc, Max 4.5 V dc
Battery Type	AA Size. LR6 Alkaline / HR6 NiMH.
Low Battery Indication	Battery level indication on display with low battery warning message.
PRF	N/A
Monitor Outputs	N/A
Through Coating Measurements	Multiple-Echo mode with Single element 0° probe; <ul style="list-style-type: none"> • Through coating measurement for coatings up to 3 mm thick as standard depending on coating velocity. • Deep Coat mode provides ability to measure through thicker coatings depending on coating material. Echo-Echo mode with Twin element probe; <ul style="list-style-type: none"> • Through coating measurement for coatings up to 1 mm thick as standard depending on coating velocity.
Materials	Sound velocity from 1000 m/s to 9000 m/s [0.0390 in/us to 0.3543 in/us]

Cygnus M5-C2P Technical Specifications			
Measurement Ranges (in steel)	Single element 0° probes in Multiple Echo mode;		
	S2C probe	3 to 250 mm	[0.120 in. to 10.00 in.]
	S3C probe	2 to 150 mm	[0.080 in. to 6.000 in.]
	S5C/A probes	1 to 50 mm	[0.040 in. to 2.000 in.]
	Twin element probes in Single Echo mode;		
	T2C probe	2.5 to 250 mm	[0.098 in. to 10.00 in.]
	T5B probe	1.5 to 200 mm	[0.059 in. to 7.900 in.]
	T7A probe	0.8 to 50 mm	[0.031 in. to 2.000 in.]
	Twin element probes in Echo-Echo mode;		
	T2C probe	5.0 to 50 mm	[0.200 in. to 2.000 in.]
	T5B probe	4.0 to 50 mm	[0.160 in. to 2.000 in.]
	T7A probe	3.0 to 25 mm	[0.120 in. to 1.000 in.]
Probe Zero	<p>Twin element probes are zeroed in the air without the need of a zero block. The user is prompted to zero the probe at power up and after a probe change.</p> <p>Single element probes in multiple echo mode do not need to be zeroed.</p>		
Measurement Modes	<p>Single Echo mode with Twin element probe. Measures thickness using the time from the delay line (zero point) to the first back-wall echo. (UT Mode 2)</p> <p>Echo-Echo mode with Twin element probe. Measures thickness using the time between the first and second back-wall echoes. (UT Mode 3)</p> <p>Multiple Echo using Single element probe. Uses three matched and verified back-wall echoes to determine the material thickness and ignore surface coatings.</p>		
High Temperature Measurement	<p>All standard single element and twin element probes: Allows continuous measurement up to 75°C (160°F).</p>		

Cygnus M5-C2P Technical Specifications			
Resolution	Single Echo and Echo-Echo measurement modes;		
	Low	0.1 mm	[0.005"]
	High	0.01 mm	[0.001"]
	Multiple Echo measurement modes;		
	Low (measurement > 120 mm)	0.1 mm	[0.005"]
	Medium (measurement < 120 mm)	0.05 mm	[0.002"]
Accuracy	<p>± 0.05 mm (± 0.002") - in Multiple-Echo measurement mode, when calibrated and measuring the same material as calibrated on.</p> <p>± 0.1 mm (± 0.004") or 0.1% of thickness measurement whichever is the greatest - in Single-Echo & Echo-Echo measurement modes, when calibrated and measuring the same material as calibrated on.</p>		
Display			
Type of Display	LCD Monochrome		
Display Size	128 x 32 Pixels. 25.58 mm (W) x 6.38 mm (H)		
Display Information	Digital Thickness Value. Settings. Battery Level.		
Transmitter			
Shape of Pulse	Square		
Pulse Energy : Voltage (peak-to-peak)	70 V p-p		
Pulse Energy : Rise Time	3 ns (max)		
Pulse Energy : Pulse Duration	S2C : 220 ns S3C : 100 ns S5A / S5C : 67ns T2C : 220 ns T5B : 100 ns T7A : 67 ns HT5 : 100 ns		
Receiver			
Gain Control	Automatic Gain Control depending on probe and measurement mode.		
Frequency Range	1.0 MHz to 10.0 MHz (-6dB)		
Other Information			
Data Output and Storage	Non.		
Data Connector	USB Mini B Connector under battery cover. Can be used to update the gauge firmware and load gauge settings.		
Calibration setting storage	Calibration Data stored to Internal Flash Memory		
Calibration Mechanisms	Not required for Multiple Echo mode.		

Cygnus M5-C2P Technical Specifications	
	Automatic V-path correction for twin element probes. Option of two point calibration for twin element probes.
Display & Recall Facilities	N/A
Display Response Time	125 ms / 500 ms
Printer Output	N/A
Environmental Rating	IPX67 (Water immersion 1 metre depth for 30 minutes) MIL STD 810G Method 501.6 (High Temp +55°C) MIL STD 810G Method 502.6 (Low temp -20°C) MIL STD 810G Method 507.6 (Humidity 95%) MIL STD 810G Method 512.6 (Immersion 1m, 30min)
Shock & Impact	MIL STD 810G Method 514.7 (Vibration) MIL STD 810G Method 516.7 (Shock 20g) MIL STD 810G Method 516.7 (Transit Drop 1.22m)
Compliance	CE, UKCA, RoHS
Designed for	BS EN 15317:2000.

Specifications are subject to change for product improvement.

Table of Sound Velocities

Velocities will vary according to the precise grade and processing conditions of the material being measured.



This table is included as a guide only.

Wherever possible, the Gauge should always be calibrated on the material under test.



These Velocities are given in good faith and are believed to be accurate within the limits described above.

No liability is accepted for errors.

Velocities given are the compressional wave velocity c_l .

Material	Velocity of Sound (V)		Conversion Factor (f)
	m/s	in/us	
Aluminium (alloyed)	6380	0.2512	1.078
Aluminium (2014)	6320	0.2488	1.068
Aluminium (2024 T4)	6370	0.2508	1.076
Aluminium (2117 T4)	6500	0.2559	1.098
Brass (CuZn40)	4400	0.1732	0.743
Brass (Naval)	4330	0.1705	0.731

Brass (CuZn30)	4700	0.1850	0.794
Copper	4700 - 5000	0.1850 - 0.1969	0.794 - 0.845
Core Ten	5920	0.2331	1.000
Grey Cast Iron	4600	0.1811	0.777
Inconel	5700	0.2244	0.963
Lead	2150	0.0846	0.363
Monel	5400	0.2126	0.912
Nickel	5630	0.2217	0.951
Phosphor Bronze	3530	0.1390	0.596
Mild Steel	5920	0.2331	1.000
Tool Steel	5870	0.2311	0.992
Stainless Steel 302	5660	0.2228	0.956
Stainless Steel 347	5790	0.2279	0.978
Stainless Steel 304	5664	0.2229	0.956
Stainless Steel 314	5715	0.2250	0.965
Stainless Steel 316	5750	0.1163	0.971
Tin	3320	0.1307	0.561
Titanium	6100 - 6230	0.2402 - 0.2453	1.030 - 1.052
Tungsten Carbide	6660	0.2622	1.125
Epoxy Resin	2500	0.0986	0.422
Acrylic	2730	0.1076	0.461
Nylon (Polyamide)	2620	0.1032	0.443

Reading Conversions

If only a few measurements are to be taken on a material other than Steel, it may be easier to leave the calibration set for Steel and merely convert the readings by multiplying by the **Conversion Factor** for the material being measured.

This method avoids unnecessary recalibration.

Example.

The Gauge is calibrated for Steel [5920 m/s], but the reading is being taken on Copper [4700 m/s] :

$$T = t \times V_{\text{COPPER}} / V_{\text{STEEL}}$$

$$\begin{aligned} &= t \times 4700 / 5920 \\ &= \underline{t \times 0.794} \end{aligned}$$

thus : **T = t x f** [where: $f = V_{\text{COPPER}} / V_{\text{STEEL}}$]

where : **T = true thickness of Copper being measured**

t = actual reading obtained

f = Conversion Factor (from table)

$V_{\text{COPPER}} =$ Sound Velocity in Copper : 4700 m/s

$V_{\text{STEEL}} =$ Sound Velocity in Steel : 5920 m/s

The **Conversion Factor f**: is given for various materials in the Table of Sound Velocities

13. Recycling and Disposal (EC Countries)

The WEEE Directive (Waste Electrical and Electronic Equipment 2002/96.EC) has been put into place to ensure that products are recycled using best available treatment, recovery and recycling techniques to ensure human health and high environmental protection.

The Gauge has been designed and manufactured with high quality materials and components which can be recycled and reused. It may contain hazardous substances that could impact health and the environment. In order to avoid the dissemination of those substances in our environment and to diminish the pressure on natural resources we encourage you to dispose of this product correctly.



DO NOT dispose of this product with general household waste.

DO dispose of the complete product including cables, plugs and accessories in the designed WEEE collection facilities.

This product may also be returned to the agent or manufacturer who supplied it for safe end-of-life disposal.

Cygnus Instruments Ltd registration number for The WEEE Directive is WEE/HE1274RU.

14. Warranty Information

LIMITED THREE YEAR WARRANTY FOR CYGNUS ULTRASONIC THICKNESS GAUGES

1. Cygnus Instruments Limited ("CYGNUS") warrants that, subject as set out below, the Products manufactured by it (excluding consumables, batteries, probes, leads, microphones and telescopic extensions) will be free from defects in materials and workmanship for a period of three years from the date of purchase either from CYGNUS or from an Authorised CYGNUS Distributor. Batteries, probes, leads, microphones and telescopic extensions are warranted for 6 months. This warranty is limited to the original Purchaser of the Product and is not transferable. During the warranty period, CYGNUS will repair, replace or refund, at its option, any defective Products at no additional charge, provided that the product is returned by the original Purchaser, shipping prepaid, to CYGNUS or an Authorised CYGNUS Distributor. If shipped by mail or any common carrier, the Purchaser must insure and accept all liability for loss or damage to the Product and must use shipping containers equivalent to the original packaging. Replacement products or parts will be furnished on an exchange basis only. All replaced products or parts become the property of CYGNUS.
2. Any defects in materials or workmanship must be notified to CYGNUS by the Purchaser within seven days after the discovery of the defect or failure.
3. Dated proof of purchase must be provided by the Purchaser when requesting warranty work to be performed or making any other claim under this warranty. CYGNUS will not be liable under this warranty unless the total price for the Product was paid by the due date for payment.
4. This warranty does not extend to any products which have been damaged as a result of, accident, misuse or abuse, natural or personal disaster, service, modification or repair by anyone other than CYGNUS or an Authorised CYGNUS Service Centre, failure to properly store or maintain the Product, negligence, abnormal working conditions, fair wear and tear, or failure to follow the instructions issued by CYGNUS in relation to the Product.
5. Except as expressly set forth above or in the CYGNUS Terms of Sale, subject to which the Products were purchased, all warranties, conditions or other terms implied by Statute or Common Law are extended to the fullest extent permitted by law.
6. Except in respect of death or personal injury caused by the negligence of Cygnus, Cygnus shall not be liable to the Purchaser or to any other person by reason of any representation (unless fraudulent), or any implied warranty, condition or other term, or any duty at common law, or under the express terms of the contract for purchase of the Products, for loss of profit or for any indirect, special or consequential loss or damage, costs, expenses or other claims for compensation whatsoever (whether caused by the negligence of Cygnus, its employees or agents or otherwise) which arise out of or in connection with the supply of the Products or their use or resale by the Purchaser or by any other person. The entire liability of Cygnus under or in connection with the Products shall not exceed the price paid for the Products, except as expressly provided in this warranty.

15. Index

- Automatic Power Off, 23
- Batteries
 - Fitting, 9
 - Level, 27
 - Life, 27
 - Low Battery Warning, 27
 - NiCad, 9
 - NiMH, 9
- Belt Clip, 12
- BS EN 15317:2007, 29
- Calibration
 - Conversion Factor, 58
 - Ladder Step Wedge, 31
 - Single Point, 29
 - Two Point Calibration, 31
 - Velocity of Sound, 35
- Deep Coat, 43
- Display
 - Rotate, 46
- Disposal, 60
- Echo-Echo, 16
- Gauge
 - Cleaning, 52
 - Display, 22
 - Keys, 22
 - Serial Number, 23
 - Version Number, 23
- Hand Strap, 11
- Ignore Coatings, 15
- Imperial, 41
- Main Menu, 37
- Measurement
 - Pitted surface, 48
- Measurement
 - Resolution, 42
 - Rough surfaces, 48
 - Small Pipes, 26
 - Stability, 25
 - Units, 41
- Metric, 41
- Multiple Echo, 15
 - Echo Bars, 25
- Neck Strap, 12
- No Probe Message, 23
- Plastics, 17
- Power button, 23
- Probes
 - Automatic Detection, 40
 - Cable, 10
 - Connector, 22
 - Knurled Ring, 19
 - Membrane Couplant, 19
 - Membrane Key, 19
 - Polyurethane Membrane
 - Membrane, 17
 - Type, setting, 39
 - Zero, 33
- Recycling, 60
- Repair, 53
- Resolution, 42
- Service, 53
- Single Echo, 15
- Sound Velocities, 57
- Test block, 29
- Thick Coatings, 43
- Thickness Measurement, 24
- Troubleshooting, 49
- Units, 41
- Vibrate Alert, 45
- Warranty, 61
- WEEE Directive, 60
- Zeroing, 33