



vision
without
limits

SUGAR INDUSTRY

CANTY

PROCESS TECHNOLOGY

BUFFALO

DUBLIN

THAILAND

Sugar Process Layout

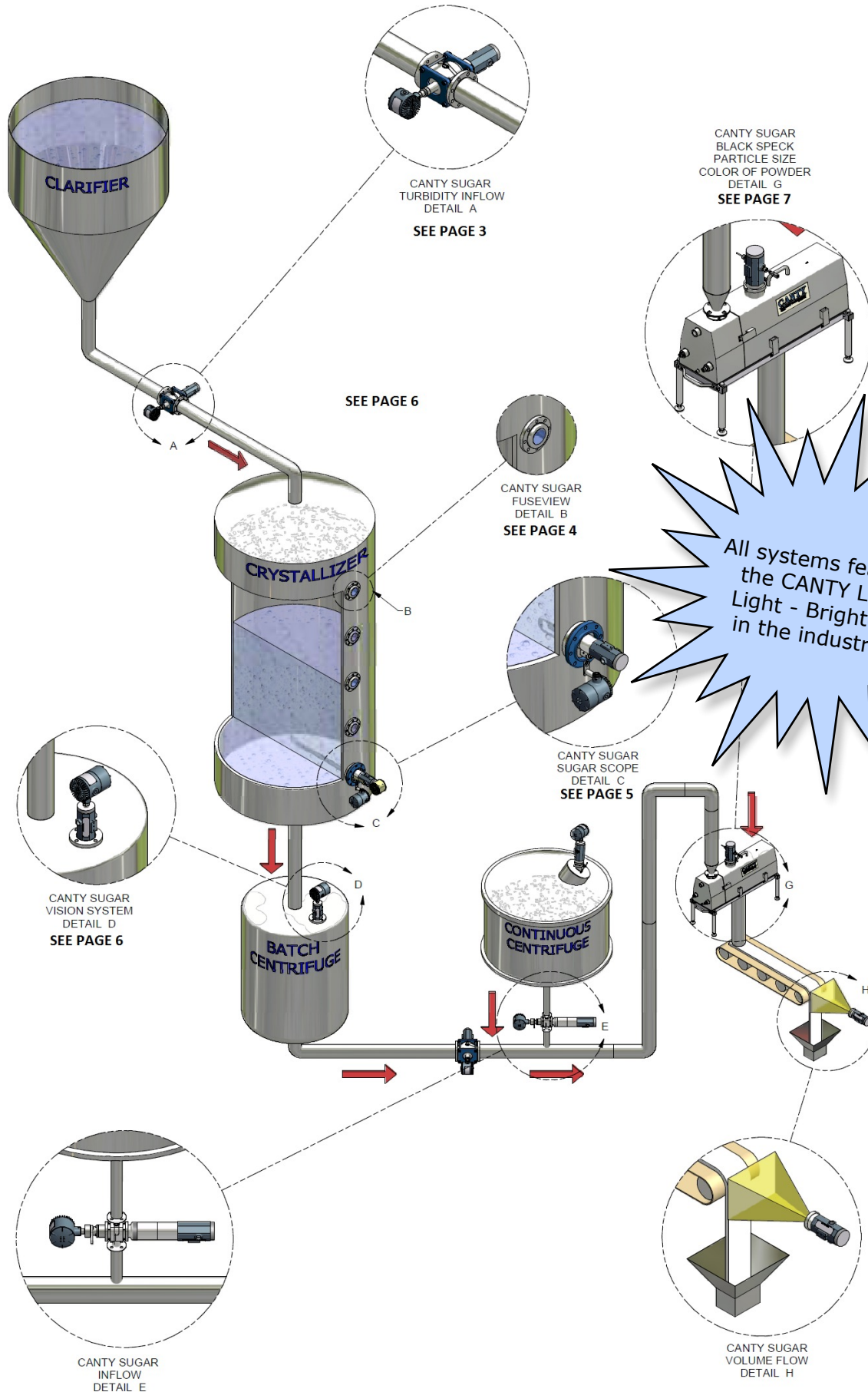

Sugar Crystallization

FUSEVIEW™ SIGHT GLASS

The sugar crystallisation process is typically monitored by operators viewing through a series of the sight glasses on the side of the vessel.

The process takes place under vacuum, so it is important to have no leak paths in order to maintain a full vacuum, boil at a lower temperature, and therefore save on energy. If a tempered glass sight glass is used, it is often installed without being fully tightened in place due to the risk of cracking the window either during installation, or during process operation as the unit experiences local expansion and contraction during temperature cycling.

By using a CANTY FuseView™ which features a metallic outer ring fused to glass, the user is tightening on metal so cannot over torque and damage the window. As a result, a full seal is maintained, and so a full vacuum is achieved, resulting in significant energy savings.

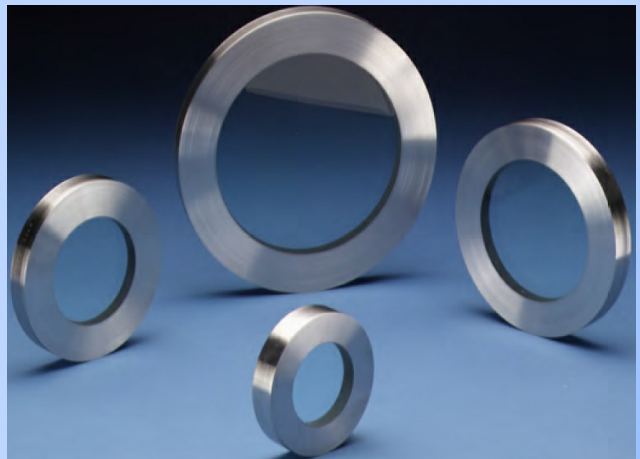

<i>Crystal Pan Capacity (Litres)</i>	<i>Savings per Batch per Degree Celsius °C*</i>	<i>Crystal Pan Capacity (US Gallons)</i>	<i>Savings per Batch per Degree Fahrenheit °F*</i>
25000	\$3.00	7500	\$1.50
50000	\$6.00	15000	\$3.00
100000	\$12.00	30000	\$6.00

* Savings calculated using $Q = mCp(T2 - T1)$, and based on initial process fluid heat up costs only - additional savings would be gained on energy savings to maintain lower required process boiling temperature

The Engineered Advantage

CANTY FuseView™ sight glasses have been engineered to meet all of your process and safety needs. By fusing glass and metal together to form a one piece construction, we can offer the largest view area of any glass-metal sight glass, for any given process connection. Our unique fused glass windows also far exceed all conventional tempered glass windows in safety and performance. CANTY windows can be easily removed for cleaning and do not have to be discarded in the same way as traditional tempered glass windows.

FuseView™	Tempered Glass
Torque applied to metallic ring - no danger of cracking during installation	Torque applied to glass - low allowance, and minimal tolerance for differential between bolts - easy to crack during installation
Bolt, unbolt, remove, refit... No residual stress problems	Once removed should be replaced with new unit - torque on glass during installation creates residual stress points, removing and refitting leads to opposing stress points, and cracking!
1 gasket required	2 gaskets required
High impact resistance	Low impact resistance - can shatter into multitude of small fragments

How it Works!

To manufacture a FuseView™ we heat the glass to its molten point where it flows to the wall of the metal. At that point the glass fuses or bonds to the metal. Then we slowly cool the FuseView™ until the glass solidifies. The metal has a higher coefficient of expansion than the glass and the metal compresses on the glass. This squeezing prestresses the glass and puts it under uniform radial compression. Glass is strong in compression but not under tension or shear. When the FuseView™ is pressurized the glass bends and relieves the compression and avoids tension. This is the same as is done with concrete - it is prestressed in compression in order to take bending.



Turbidity

Turbidity / CIP

- Monitor for TOC and Particle Level
- Reduce Lab Time
- Monitor for TSS

Turbidity

Turbidity analysis using a high resolution CCD/CMOS image sensor that detects turbidity changes in fluids by measuring the transmittance of light. Using advanced software algorithms the system automatically removes gas bubbles from the analysis resulting in highly accurate and repeatable data outputs. This system is designed for inline use with varying pressures, temperatures, and pipe diameters.

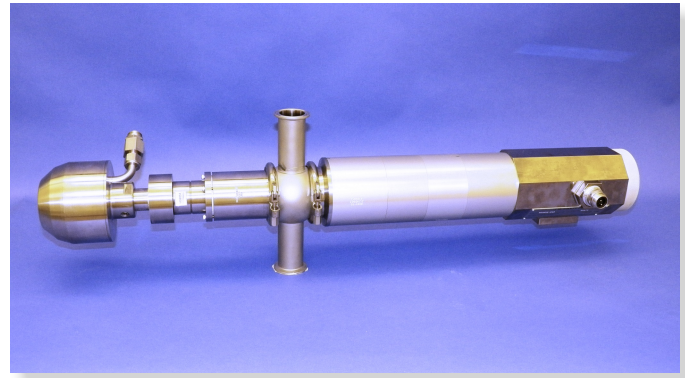

Effect of Gas Bubbles

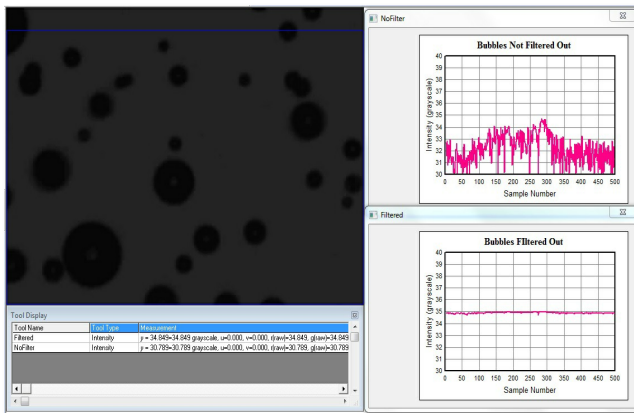

Features

- Ethernet Connectivity
- Real Time Monitoring Of Process In Flow
- Solid One Piece Central Hub
- Supplied With Internal O-Ring Seals
- Easily Installed Modular Unit
- Fused Glass Process Barriers
- Regulated Light Source Emits Cold Light To Prevent Product Bake-On
- OPC, 4-20mA Current Loop, EXCEL Spreadsheet And Relay Outputs Are Available
- Single-Use Options Are Available
- Visual Verification
- In-Line Analysis

Turbidity (NTU)



Vector Control Module



The Vector Control Module (VCM) is a small fanless solid state embedded processor that has CANTYVISION™ software pre-installed. It is designed to keep project costs low and to also eliminate the need for a computer. Since the VCM has analog outputs, there is no need for an additional analog output module purchase*. The operator screen makes it simple for operators to see what is going on real time with visual verification.

The VCM has OPC or 4-20mA outputs to a PLC or DCS for complete control. The VCM comes with the ability to have full administration controlled passwords and permissions. This compact design and cost effective system is easily setup and has a customizable screen. Access to technical support can be obtained with Internet connection.

- Supports up to six cameras
- OPC outputs
- Up to eight analog 4-20mA outputs
- Link to technical support (when Internet connected)
- Digital IO
- Four USB Ports
- Four serial ports
- CantyVision™ Software installed
- Full administrative control embedded operating system
- Fan-less solid state vision control system

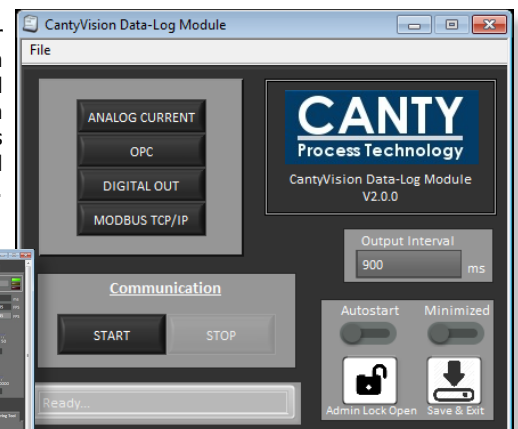
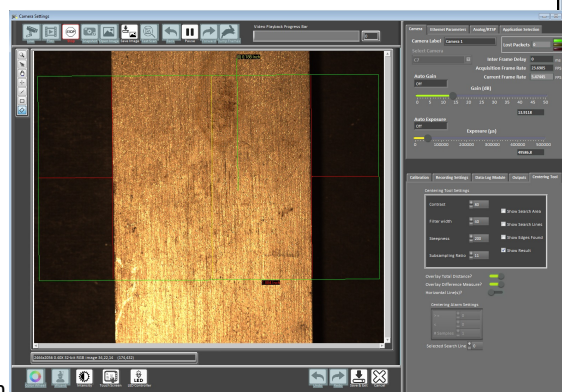

Sugar Crystallization



SUGARSCOPE™

The CANTY SugarScope™ allows for remote monitoring of the crystallization process, providing the control room operators with a continuous, real time, microscopic view.

The equipment can be easily retrofitted to a vacuum pan, by utilizing one of the flange connections previously designated for a sight glass.

The system can be supplied with fixed optics, or a dynamically adjustable 7:1 zoom capability to allow the user to adjust their magnification and field of view to suit the crystal size at any point in the process.

Having a continuous view available to the operators avoids the archaic method of manually viewing crystals on a glass slide at various points in the process, and therefore allows for early problem detection (eg. secondary seeding) and swift operator reaction.

CantyVision™ image analysis software allows for particle size and shape characterization during the initial stages of crystal growth, along with providing the Mean Aperture (MA) and Coefficient of Variation

The SugarScope™ combines the latest Gigabit Ethernet camera systems, with CANTY's patented fused glass and lighting technologies, to provide an unrivalled view, from initial nucleation right through to fully formed crystals.

The insertion section of the system ensures the view is representative of the process as a whole, rather than viewing at the vessel wall, where crystal behavior and characteristics may be affected by boundary layer phenomena.

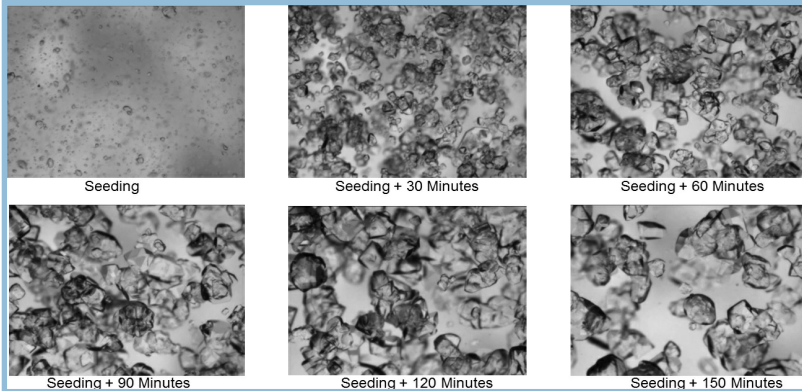
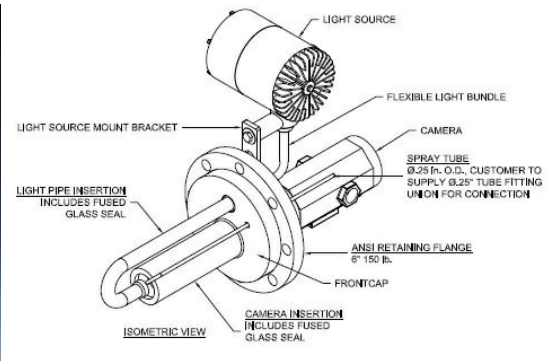

- Continuous Real Time Visual
- Measurement to 0.7µm
- Crystal Size & Shape
- Removes Operator Subjectivity
- MA & CV Data
- Visual Verification
- Simple Retrofit

Sugar Color - ICUMSA (IU) Clarifier

ICUMSA GS2/3-10

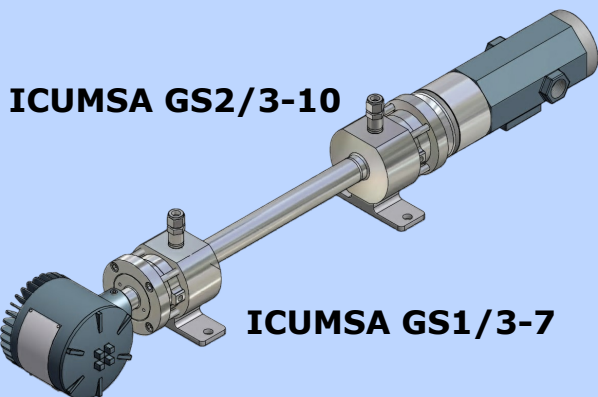

ICUMSA GS1/3-7

A variation of the Inflow™, featuring a longer flow path, can also be used for measuring the color of sugar on the ICUMSA scale.

A regulated LED light source ensures that each liquid sample is subjected to consistent lighting conditions, while a highly color sensitive CCD camera provides representative images of the fluid for measurement, via the image analysis software.

The same color intensity, and bubble elimination software are employed. However instead of calibrating the 0-255 grayscale value to a turbidity scale, it is instead calibrated against the appropriate ICUMSA standard via known value samples. This allows for the measurement of the IU value of any white sugar solution (ICUMSA GS2/3-10) or raw, brown or colored syrup sugar solutions (ICUMSA GS1/3-7).

Sugar Centrifuging

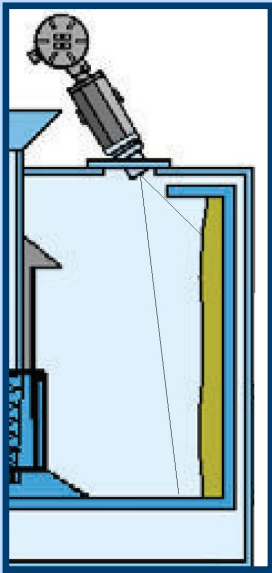

A camera light combination system is mounted to the centrifuge using the CANTY angled mounting plate. This allows for continuous monitoring from the control room, of initial product filling, the various washing and spinning cycles, and product discharge, therefore enabling greater operator control and efficient identification of any process issues.

CantyVision™ image processing software can be used to measure and detect various process parameters on both batch and continuous centrifuge systems.



Cake Thickness • Color Line Control • Wash Optimization

The CantyVision™ Level / Edge tool, can be configured to track any edge based on the difference in color or grayscale of 2 materials / components. In a batch centrifuge, this edge is the intersection between the product cake, and the centrifuge base plate. This edge tracking is a direct measurement of the cake thickness.

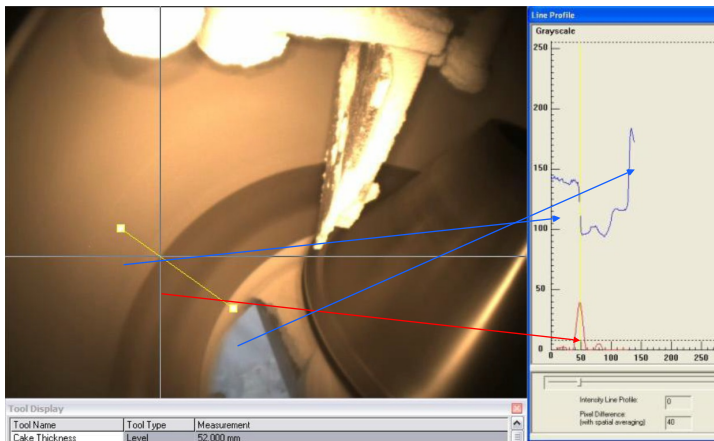

In a continuous centrifuge, the same Level / Edge tool can be configured to track the position of the color line. This allows the operator to adjust the feed conditions to maintain a constant color line position, and avoid washing above the color line, which is inefficient due to spacing on screen and subsequent liquid carry over.

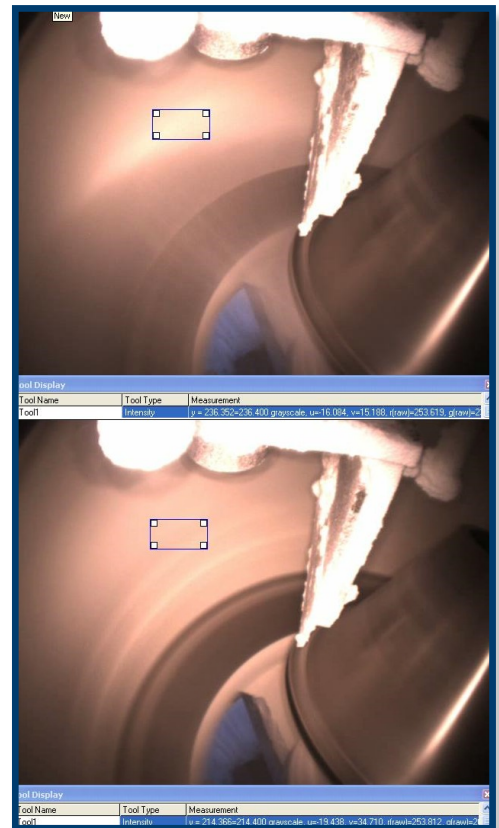

The CantyVision™ Intensity tool can be used to optimize the product washing & spinning phases of the centrifuge process.

If there is overstanding liquid present on the surface of the cake during washing, it indicates less than optimal filtration, which could be due to too high a wash fluid feed rate, or possibly fine particles plugging the filter mesh (indicative of a problem with crystallization).

This overstanding liquid is detected by CantyVision™, as when liquid is present, there is a higher than normal intensity reading due to the reflection of the imaging system's light source from the surface. In addition to detecting the initial presence of overstanding liquid, a subsequent drop in intensity reading indicates that all wash fluid has eventually been filtered through. This can be used to control the introduction of additional wash cycles, or to determine when the washing process is complete and the product can be discharged.

Solids Particle Sizing

**Meets ASTM Standards • Raw Crystal Sugar • Purified Sugar • Baking Sugar
Particle Size from 10µm to no upper limit***

Size and shape analysis of dry particles or pellets, is performed by the range of Cauty Solid Sizer equipment. The product to be analysed is fed into the system hopper, where the built in material handling system separates the particles into one even layer, and transports them into the analyser's measurement zone.

Within the measurement zone, the particles pass between a high intensity LED light source and camera, which captures high resolution images 2D images.

These images are then binarized, and by analysing the number and position of the image pixels, a full particle **SIZE** and **SHAPE** distribution.

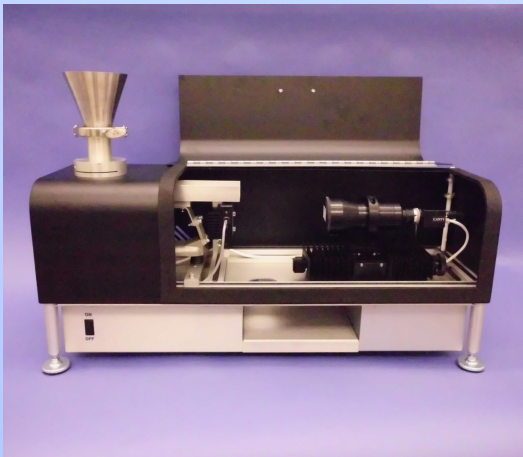
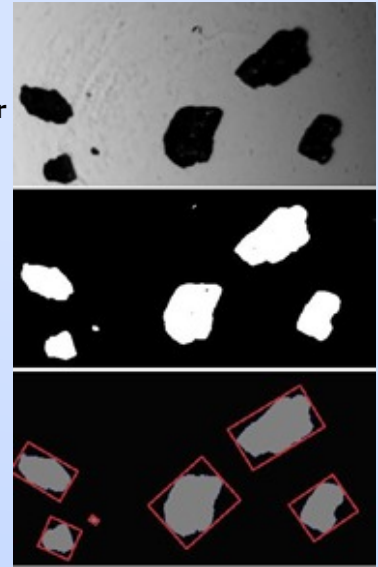

Lab or Industrial (At-Line) Systems

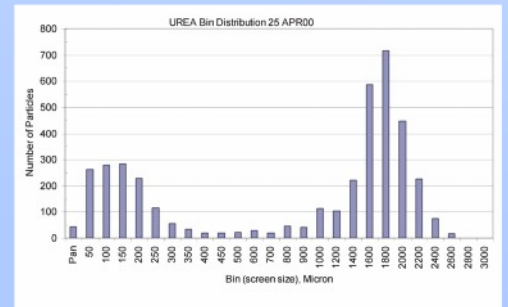
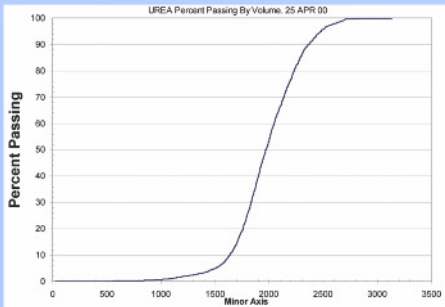

BLACK SPECK or **COLOR SPECK** detection is available as an add on to a particle size and shape analyser, or as a stand alone system. This uses a camera system with controlled front lighting system for accurate color representation within the captured images. Multiple measurement zones can be configured to allow for detection of particles of different colors within the same product.

Contaminant Detection - Mixture Ratio Analysis

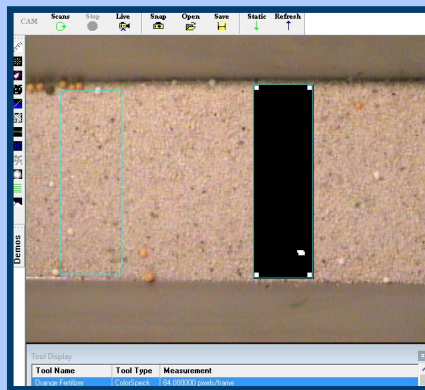

Color Particles Detected

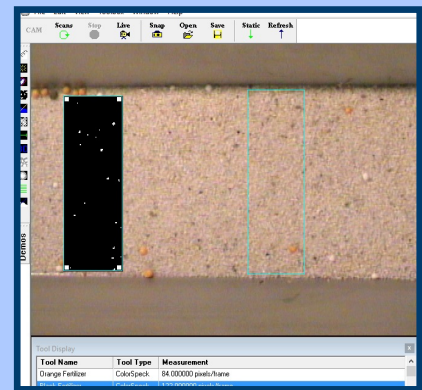

Black Particles Detected

CANTY'S GOAL IS TO PROVIDE EQUIPMENT TO ENHANCE PROCESS CONTROL AND YIELD. WE ACCOMPLISH THIS BY DESIGNING, MANUFACTURING AND SERVICING THE FINEST EQUIPMENT IN THE WORLD

SOME OF OUR VALUED CUSTOMERS

AMERICAN CRYSTAL SUGAR

ASR GROUP

DOMINO SUGAR

TATE & LYLE

REDPATH SUGAR

FLORIDA CRYSTALS

AMALGAMATED SUGAR

SUGAR AUSTRALIA

C & H SUGAR

APPLICATIONS:

TURBIDITY

SUGAR COLOR - ICUMSA

CRYSTALLIZATION

CENTRIFUGE

COLOR LINE/EDGE DETECTION

FILL LEVEL & CAKE DETECTION

PARTICLE SIZE

BLACK SPECK DETECTION



J.M. Canty Inc.
6100 Donner Road
Buffalo, NY 14094
Phone: (716) 625 - 4227
Fax: (716) 625 - 4228

Email: sales@jmcanty.com



J.M. Canty International Ltd.
Ballycoolin Business Park
Blanchardstown
Dublin 15, Ireland
Phone: +353 (01) 882 - 9621
Fax: +353 (01) 882 - 9622

Email: sales.ie@jmcanty.com

WWW.JMCANTY.COM